

# PIONEER™ FAMILY

PROFESSIONAL ILLUMINATION LIGHTING

Put the Light Where You Need It Most with  
Whelen's Super-LED® Work Lights

E2-12

LADDER

**WHELEN**  
MANUFACTURED IN AMERICA

# TABLE OF CONTENTS

Pioneer Micro™ .....3  
 Pioneer Summit™ .....4  
 Pioneer Nano™ .....6  
 Pioneer Plus™ .....7  
 Pioneer SlimLine™ .....8  
 Pioneer Plus 115 VAC .....10  
 Pioneer Plus Mounting.....11  
 Pioneer Plus Surface Mount.....12  
 3000 and 3100 Pioneer Pole Mount ..13  
 3050 Series Pioneer Pole Mount .....15  
 3200 Series Pioneer Folding Tripod...16  
 3300 Series Pioneer Ground Tripod...17

## ABOUT WHELEN



Whelen Engineering designs and manufactures reliable and powerful warning lights, white illumination lighting, sirens, controllers, and high-powered warning systems for Automotive and Mass Notification industries worldwide. Whelen products have been proudly designed and manufactured in America since 1952. With quality as the foundation, Whelen celebrates innovative engineering with every product made.

**Manufactured in America for over 70 years. We never left and we're here to stay.**



**Visit us at whelen.com**

To learn about our full line of emergency lighting and warning products.



To download WeCad™, Whelen Command®, and Pioneer™ Designer go to [whelen.com/software-downloads](http://whelen.com/software-downloads)

@WhelenENG



**Chester, Connecticut facility**



**Charlestown, New Hampshire facility**

# ICON LEGEND



12 Volt



24 Volt



120 AC



IP67  
Rated



AC Models UL  
Approved



Cruise



Hard Coated



Low Current  
Switching



Standard  
Current



NFPA



Sync



1 Year  
Warranty



2 Year  
Warranty



5 Year  
Warranty



Scan-Lock™



Real Time  
Diagnostics



SAE Class 1



SAE Class 2



SAE Class 3



DVI™  
Enabled



WeCan®  
Compatible



WeCanX®  
Compatible



## Pioneer™ Designer

### System Requirements

- Microsoft Windows® Vista, Windows 7, Windows 8/8.1, or Windows 10
- 500MB of RAM (1GB recommended)
- 25MB of available hard disk space

### Additional Prerequisites

- Windows Installer 3.1
- .NET Framework 4.0 (automatically checked during the installation, and may require additional hard disk space)

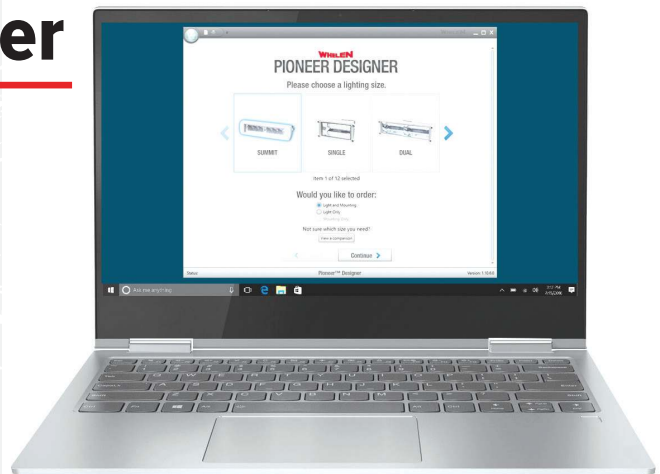

### CHOOSE A MODEL

**MODELS**

- NEW 2017 Pioneer Plus Floodlight, 150 Watts
- NEW 2017 Pioneer Plus Flood/Spot, 75/75 Watts
- Pioneer Floodlight, 70 Watts
- Pioneer Plus Floodlight, 150 Watts**
- Pioneer Plus Combo Spot/Flood Dual Panel, 75/75 Watt
- Pioneer Plus Floodlight, 8 Deg. Spotlight, 75/75 Watts
- Pioneer Plus 8 Deg. Spotlight, Floodlight, 75/75 Watts

Current Model Number: PPF2B

The above image demonstrates light output.

**ADDITIONAL OPTIONS**

Color:

Black

White

### ORDERING INFORMATION

Date: 9/17/2019

Account Number:

Purchase Order:

Billing Address:

Shipping Address:

First Name:

Last Name:

Company Name:

Address:

Address 2:

City:

Country:

State:

Region/Province:

Zip:

# Pioneer Micro™



Download Pioneer™ Designer for a list of available options.



## FEATURES

- 8° spotlight pattern comes standard. Includes three additional optic lenses for a light pattern choice of:
  - 90° x 20° wide flood
  - 40° x 20° standard flood
  - 40° x 8° narrow flood
- Optic lens changes easily via removable lens retainer
- Injection molded polycarbonate lenses are impact resistant and hard-coated
- Die-cast aluminum powder-coated housing in Black or White
- Solid-state electronics
- LEDs are instant On/Off, eliminating high inrush current and ramp-up time
- Correlated Color Temperature (CCT) of 5,700° Kelvin simulates bright midday light
- Includes 6' cable
- Five mounts available:
  1. Powder-coated stainless steel bail bracket with 3/8" - 16 stud carriage bolt mount
  2. Recessed 90° angle mount with Chrome flange
  3. Recessed 15° angle mount with Chrome flange
  4. Pole/pedestal mount with handle available with or without On/Off switch
  5. Low-profile pedestal mount available with Chrome or Black back cover, with or without On/Off switch

MODEL	DESCRIPTION	LUMENS*
MPBW	Bail/Stud Mount, White Housing	5,695
MPBB	Bail/Stud Mount, Black Housing	
MPPW	Low-Profile Pedestal/Swivel Mount, White Housing	
MPPWCS	Low-Profile Pedestal/Swivel Mount, Chrome Cover, White Housing and On/Off Switch	
MPPB	Low-Profile Pedestal/Swivel Mount, Black Housing	
MPPBBS	Low-Profile Pedestal/Swivel Mount, Black Cover, Black Housing and On/Off Switch	
MPPBCS	Low-Profile Pedestal/Swivel Mount, Chrome Cover, Black Housing and On/Off Switch	
MPRW	Straight Recessed Mount, White Housing	
MPRB	Straight Recessed Mount, Black Housing	
MPR15W	15° Recessed Mount, White Housing	

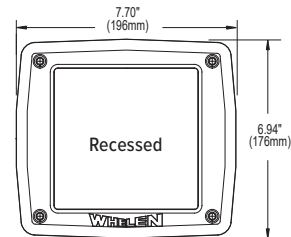
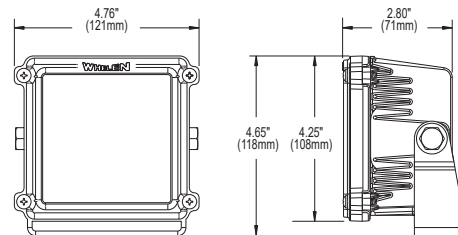

\*Total design lumens produced at time of publication. LED flux BINS periodically increase due to evolution of LED technology. Whelen reserves the right to increase lumen output when higher flux BINS are available.

# Pioneer Summit™ and Pioneer Summit Brow Light



Download Pioneer™ Designer for a list of available options.



## FEATURES

- SAE 578 Color Temperature Certified
- Preconfigured spot, flood, or scene optics
- Available with White illumination, Amber marker, and warning lights
- Warning lights require a remote flasher, purchased separately
- Individual control of each set of optics
- Hard-coated lenses minimize environmental damage from sand, sun, salt, and road chemicals
- Extruded and die-cast aluminum powder-coated housing available in Black or White
- Screwless lens retainer design provides a clean finish
- 100% solid-state electronics
- Multiple mounting options available
- Includes 2' cable, connector, and heat shrink tubing

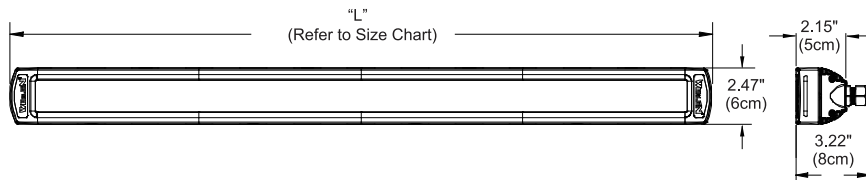

### Pioneer Summit

#### "L" Size Chart

30" (76cm)	44.37" (113cm)
---------------	-------------------

### Pioneer Summit Brow Light

#### "L" Size Chart

58.37" (148cm)	72.37" (184cm)	88.37" (224cm)
-------------------	-------------------	-------------------



**WARNING:** This product may contain chemicals known to the State of California to cause cancer and birth defects or other reproductive harm. For more information, visit [whelen.com/regulatory](http://whelen.com/regulatory).



# Pioneer Nano™



Download Pioneer™ Designer for a list of available options.



## FEATURES

- 8° spotlight pattern comes standard. Includes additional optic lens for a light pattern of:
  - 40° x 20° flood
- Optic lens changes easily via removable lens retainer
- Injection molded polycarbonate lenses are impact resistant and hard-coated
- Die-cast aluminum powder-coated housing in Black or White
- Solid-state electronics
- LEDs are instant On/Off, eliminating high inrush current and ramp-up time
- Correlated Color Temperature (CCT) of 5,700° Kelvin simulates bright midday light
- Includes 6' cable
- Powder-coated stainless steel bail bracket with 1/4" - 20 stud carriage bolt mount

MODEL	DESCRIPTION	LUMENS*
NP3BW	3-LED, Bail Mount, White Housing	1,566
NP3BB	3-LED, Bail Mount, Black Housing	
NP6BW	6-LED, Bail Mount, White Housing	2,552
NP6BB	6-LED, Bail Mount, Black Housing	

\*Total design lumens produced at time of publication. LED flux BINS periodically increase due to evolution of LED technology. Whelen reserves the right to increase lumen output when higher flux BINS are available.

Consult current price list for full list of available options at [whelen.com/literature](http://whelen.com/literature).

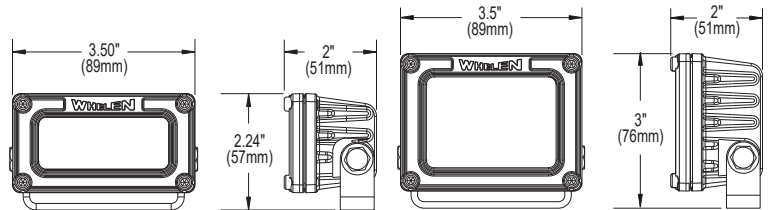

**WARNING:** This product may contain chemicals known to the State of California to cause cancer and birth defects or other reproductive harm. For more information, visit [whelen.com/regulatory](http://whelen.com/regulatory).

# Pioneer Plus™



Download Pioneer™ Designer for a list of available options.



## FEATURES

- Available in single and dual models
- Pioneer Plus Combination Floodlight/Spotlight features Proclera® Optic Technology
- Injection molded polycarbonate lenses are impact resistant and hard-coated
- Die-cast aluminum powder-coated housing in Black or White
- Solid-state electronics
- LEDs are instant On/Off, eliminating high inrush current and ramp-up time
- Correlated Color Temperature (CCT) of 5,700° Kelvin simulates bright midday light
- Powder-coated stainless steel bail bracket
- DC models include 20' cable, AC models include 12" wire leads

Model	Description	Lumens*
PFH1	Single Panel Floodlight	10,130
PCH1	Single Panel Combination Flood/Spot	
PFH2	Dual Panel Floodlight	20,261
PCH2	Dual Panel Combination Flood/Spot	
PFH1AC	Single Panel Floodlight, 115 VAC	10,130
PSP1AC	Single Panel, Spotlight, 8°, 115 VAC	
PFH2AC	Dual Panel Floodlight, 115 VAC	20,261
PCP2AFS	Dual Panel, Combination Flood/Spotlight, 115 VAC	
PCP2ASF	Dual Panel, Combination Spot/Floodlight, 115 VAC	
PCP3	Max Combination Flood and 8° Spotlight	19,305
PCP3A	Max Combination Flood and 8° Spotlight, 115 VAC	19,819

\*Total design lumens produced at time of publication. LED flux BINS periodically increase due to evolution of LED technology. Whelen reserves the right to increase lumen output when higher flux BINS are available.

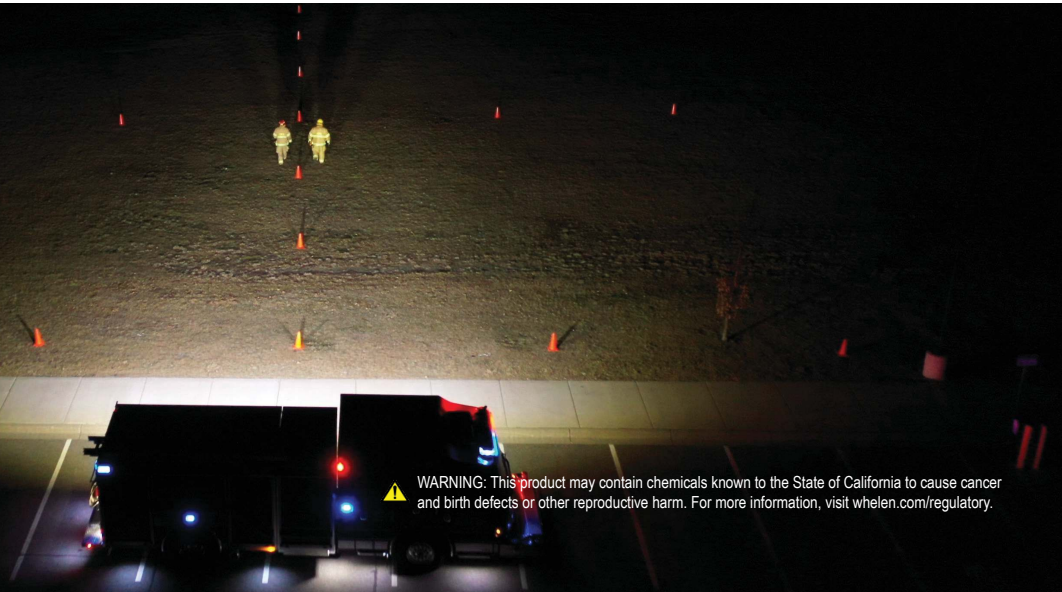
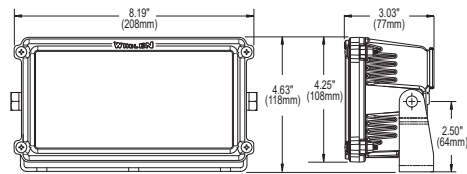
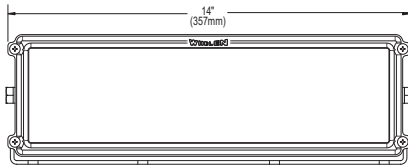

# Pioneer SlimLine™



Download Pioneer™ Designer for a list of available options.



## FEATURES

- Available in single or dual models
- Single Lamp Models: 8° spotlight pattern comes standard
  - Includes additional 40° x 20° flood lens
- Dual Lamp Models: 8° spotlight pattern comes standard  
Includes two additional optic lenses for a light pattern choice of:
  - Dual 40° x 20° flood
  - 8° spot and 40° x 20° flood
- Optic lens changes easily via removable lens retainer
- Injection molded polycarbonate lenses are impact resistant and hard-coated
- Die-cast aluminum powder-coated housing in Black or White
- Solid-state electronics
- LEDs are instant On/Off, eliminating high inrush current and ramp-up time
- Correlated Color Temperature (CCT) of 5,700° Kelvin simulates bright midday light
- Includes 6' cable
- Powder-coated stainless steel bail bracket

MODEL	DESCRIPTION	LUMENS*
PSL1B	Single Panel, Bail/Stud Mount, White Housing	5,103
PSL1BB	Single Panel, Bail/Stud Mount, Black Housing	
PSL1P	Single Panel, Low-Profile Pedestal/Swivel Mount, White Housing	
PSL1PB	Single Panel, Low-Profile Pedestal/Swivel Mount, Black Housing	
PSL1R	Single Panel, Semi-Recessed, Chrome Flange Mount, White Housing	
PSL1RB	Single Panel, Semi-Recessed, Chrome Flange Mount, Black Housing	
PSL1R5	Single Panel, Semi-Recessed 15° Angle Chrome Flange Mount, White Housing	
PSL1R5B	Single Panel, Semi-Recessed 15° Angle Chrome Flange Mount, Black Housing	
PSL2B	Dual Panel, Bail/Stud Mount, White Housing	10,206
PSL2BB	Dual Panel, Bail/Stud Mount, Black Housing	
PSL2P	Dual Panel, Low-Profile Pedestal/Swivel Mount, White Housing	
PSL2PB	Dual Panel, Low-Profile Pedestal/Swivel Mount, Black Housing	
PSL2R	Dual Panel, Semi-Recessed, Chrome Flange Mount, White Housing	
PSL2RB	Dual Panel, Semi-Recessed, Chrome Flange Mount, Black Housing	
PSL2R5	Dual Panel, Semi-Recessed 15° Angle Chrome Flange Mount, White Housing	
PSL2R5B	Dual Panel, Semi-Recessed 15° Angle Chrome Flange Mount, Black Housing	

\*Total design lumens produced at time of publication. LED flux BINS periodically increase due to evolution of LED technology. Whelen reserves the right to increase lumen output when higher flux BINS are available.

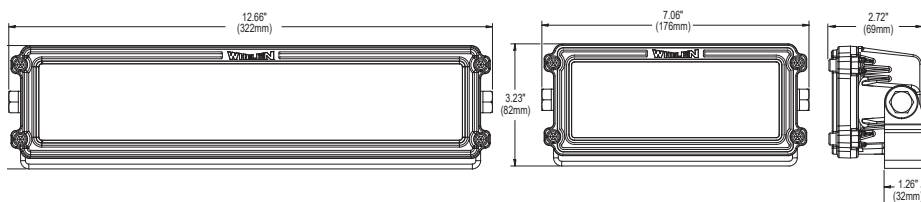



# Pioneer Plus™ 115 VAC



Download Pioneer™ Designer for a list of available options.



## FEATURES

- Available in single and dual models
- Injection molded polycarbonate lenses are impact resistant and hard-coated
- Die-cast aluminum powder-coated housing in Black or White
- Solid-state electronics
- LEDs are instant On/Off, eliminating high inrush current and ramp-up time
- Correlated Color Temperature (CCT) of 5,700° Kelvin simulates bright midday light
- Powder-coated stainless steel bail bracket
- AC models include 12" wire leads

MODEL	DESCRIPTION	LUMENS*
PSP1AC	Single 8° Spotlight, White Housing	10,130
PFP1ACB	Single Floodlight, Black Housing	
PFP1AC	Single Floodlight, White Housing	
PCP2AFS	Dual Floodlight/Spotlight, Flood: Left, Spot: Right, White Housing	20,261
PCP2ASF	Dual Floodlight/Spotlight, Flood: Right, Spot: Left, White Housing	
PCP2AFSB	Dual Floodlight/Spotlight, Flood: Left, Spot: Right, Black Housing	
PCP2ASFB	Dual Floodlight/Spotlight, Flood: Right, Spot: Left, Black Housing	
PFP2AC	Dual Floodlight, White Housing	
PFP2ACB	Dual Floodlight, Black Housing	

\*Total design lumens produced at time of publication. LED flux BINS periodically increase due to evolution of LED technology. Whelen reserves the right to increase lumen output when higher flux BINS are available.

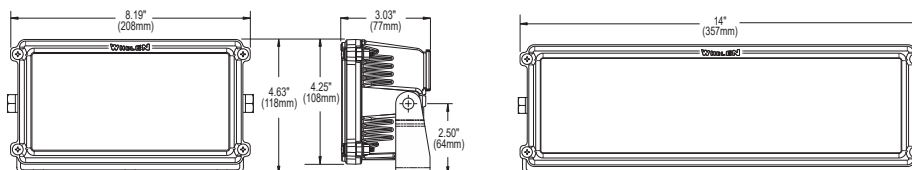

# Pioneer Plus™ Mounting



Download Pioneer™ Designer for a list of available options.

## FEATURES

The Pioneer Plus family is compatible with many secure mounting options. Mounts are available for single or dual lamp models.

- Pedestal mount
- Locking pedestal mount
- Low-profile pedestal/swivel mounting
- Universal bail bracket
- Semi-recessed with Chrome trim ring
- Vehicle specific brow mount kits
- Pole/pedestal mount



PBAPEDA/  
PBAPEDDL  
Locking Pedestal  
Mount Adapter



PBAPEDA / PBAPEDD  
Pedestal Mount Adapter



PCH2P  
Pole/Pedestal  
Mount Adapter



PBH206U  
Universal Bail Bracket



PH1LPED Low Profile  
Pedestal/Swivel  
Mount



PBH203  
Semi-Recessed Mount with  
Chrome Trim Ring



# Pioneer Plus™ Surface Mount



Download Pioneer™ Designer for a list of available options.



## FEATURES

- Available in single and dual models
- Injection molded polycarbonate lenses are impact resistant and hard-coated
- Die-cast aluminum powder-coated housing in Black or White
- Solid-state electronics
- LEDs are instant On/Off, eliminating high inrush current and ramp-up time
- Correlated Color Temperature (CCT) of 5,700° Kelvin simulates bright midday light
- Includes 6' cable
- Surface mount:
  - Requires no body cut-outs
  - Built-in nylon screw grommets eliminate galvanic corrosion
  - Uniquely designed silicone grommet seals the 1" wire entry into the body
  - Available with Chrome or Black flange

MODEL	DESCRIPTION	LUMENS*
PCPSM1C	Single, Flood/Spot, Chrome Flange	10,444
PCPSM1B	Single, Flood/Spot, Black Flange	
PCPSM14C	Single, Flood/Spot, Chrome Flange, 24VDC	
PCPSM14B	Single, Flood/Spot, Black Flange, 24VDC	
PCPSM2C	Dual, Flood/Spot, Chrome Flange	20,888
PCPSM2B	Dual, Flood/Spot, Black Flange	
PCPSM24C	Dual, Flood/Spot, Chrome Flange, 24VDC	
PCPSM24B	Dual, Flood/Spot, Black Flange, 24VDC	
PCPSM1AC	Single, Flood/Spot, Chrome Flange, 115VAC	11,231
PCPSM1AB	Single, Flood/Spot, Black Flange, 115VAC	
PCPSM2AC	Dual, Flood/Spot, Chrome Flange, 115VAC	
PCPSM2AB	Dual, Flood/Spot, Black Flange, 115VAC	22,462

\*Total design lumens produced at time of publication. LED flux BINS periodically increase due to evolution of LED technology. Whelen reserves the right to increase lumen output when higher flux BINS are available.

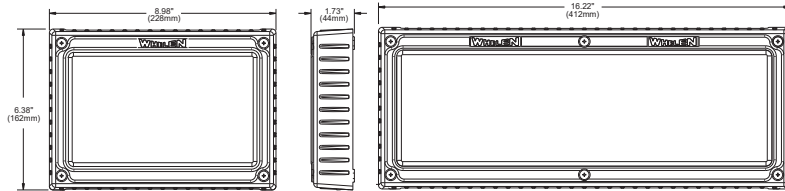

WARNING: This product may contain chemicals known to the State of California to cause cancer and birth defects or other reproductive harm. For more information, visit [whelen.com/regulatory](http://whelen.com/regulatory).

**WHELEN**  
MANUFACTURED IN AMERICA

12

# 3000 & 3100 Series Pioneer™ Pole Mounting

5YR



Download Pioneer™ Designer  
for a list of available options.

## FEATURES

- 57" extruded anodized aluminum AC and DC adjustable pole assemblies
- Available with top or bottom mount locking collar
- Outer body certified to NFPA 15.8 access handrails or handholds
- Three conductor internal input wire for AC models, four conductor internal input wire for DC models
- Side and thru body mount versions
- Requires purchase of Pioneer lighthead with pole/pedestal mount adapter
- Optional lower side mount cradle bracket
- Optional internal top mount or bottom lower cradle mount electromagnetic sensor. These indicate if the pole has been seated properly into the cradle for travel (customer supplied warning indicator light)
- Internal or external cable exit

### 3000 SERIES

### 3100 SERIES

Side Mount Pole Assemblies  
Top Mount Locking Collar

Side Mount Pole Assemblies  
Bottom Mount Locking Collar

Thru Mount Pole  
Assemblies





**⚠ DANGER**  
DO NOT RIDE ON REAR  
STEP WHILE VEHICLE IS  
IN MOTION  
DEATH OR SERIOUS  
INJURY MAY RESULT

**⚠** WARNING: This product may contain chemicals known to the State of California to cause cancer and birth defects or other reproductive harm. For more information, visit [whelen.com/regulatory](http://whelen.com/regulatory).

**WHELEN**  
MANUFACTURED IN AMERICA

# 3050 Series Pioneer™ Pole Mounting

5YR



Download Pioneer Designer  
for a list of available options.

## FEATURES

- Extruded aluminum AC pole assemblies
- Available in 30" (76cm), 40" (102cm), and 50" (127cm) lengths
- 40" (102cm) DC pole assembly available
- Side mount with Silver powder-coated non-adjustable stand-off mounting brackets available in 2", 3", 5", and 7"
- Top mount (pull-up)
- Three conductor internal input wire
- Poles and outer bodies are anodized to eliminate corrosion and yellowing
- Requires purchase of Pioneer lighthouse with pole/pedestal mount adapter

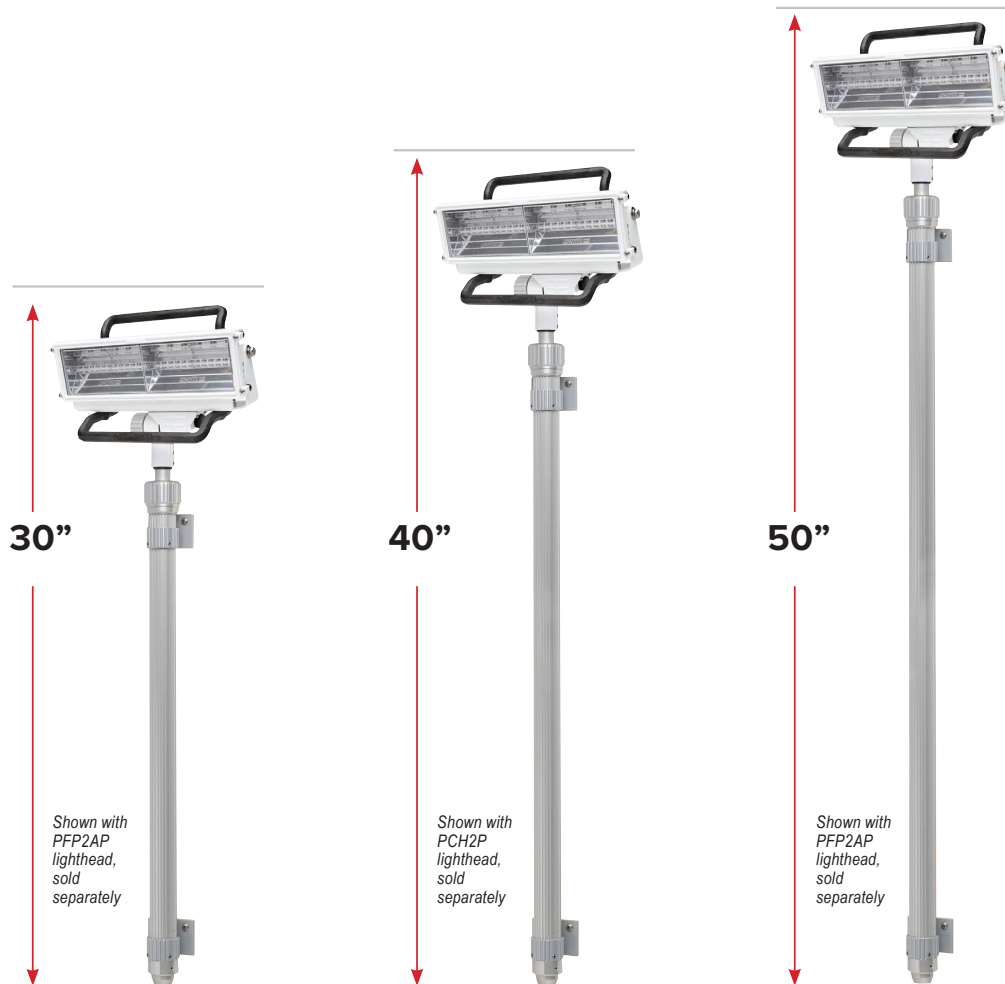

# 3200 Series Pioneer™ Folding Tripod

5YR



Download Pioneer Designer  
for a list of available options.

## FEATURES

- Extruded aluminum AC tripod assemblies
- Available in 30" (76cm), 40" (102cm), and 50" (127cm) lengths
- Tripod models are available with multiple cord and plug options:
  - Wireless for use with ground tripod
  - With inner coil cord, with or without plug
  - With loose external coil cord for top wire exit, with or without plug
- All moving aluminum parts are isolated with nylon bushings for superior industry leading adjustment and fold outs. All inner poles, outer bodies, and folding legs are anodized to eliminate corrosion and yellowing
- Requires Pioneer with pole/pedestal mount adapter (purchased separately)
- Optional tripod mounting cradle bracket with upper quick disconnect mount bracket (model 87283001)
- Optional ground tripod mounting bracket available for all folding tripods (model 87283002)



Models shown with Pioneer lighthouses, purchased separately. Shown with optional plug

# 3300 Series Pioneer™ Ground Tripod

5YR



Download Pioneer Designer  
for a list of available options.

## FEATURES

- White or Black powder-coated die-cast aluminum AC portable ground tripod
- Includes stationary quick disconnect mount
- Includes 12" cable
- Requires Pioneer with pole/pedestal mount adapter (purchased separately)
- 3300 ground tripod can be secured to the body or stowed in a compartment via the ergonomic quick disconnect spring in mounting bracket
- 3300 ground tripod can be installed on a 3200 series folding tripod, 3300 or 3100 series pole, or pedestal base using either the standard or heavy duty adapter kit
- Optional plugs available

### QUICK DISCONNECT MOUNTING BRACKET



Spring Pin  
Mounting Bracket  
(Shown)

87312001



PFP2AP1

### POLE MOUNT ADAPTER KIT



Heavy-Duty  
Adapter Kit

873120A2

-OR-



Standard Adapter Kit  
(Shown)

87283002





 WARNING: This product may contain chemicals known to the State of California to cause cancer and birth defects or other reproductive harm. For more information, visit [whelen.com/regulatory](http://whelen.com/regulatory).

**WHELEN**  
MANUFACTURED IN AMERICA

# PIONEER™ FAMILY

PROFESSIONAL ILLUMINATION LIGHTING

---

Put the Light Where You Need It Most with  
Whelen's Super-LED® Work Lights

**WHELEN**®  
MANUFACTURED IN AMERICA

@WhelenENG



**NASCAR**™  
OFFICIAL WARNING LIGHTS

*Preferred Warning Lights of* 

Whelen Engineering Company  
(860) 526-9504  
www.whelen.com

Whelen Engineering reserves  
the right to upgrade and improve  
products without notice.

© 2024 Whelen Engineering Company,  
Inc. Printed in U.S.A.  
Code No. 12243W- 3/24

All products proudly designed, manufac-  
tured, and assembled in the U.S.A.  
• ISO 9001 Registered QMS

